

# Distributed Play Box

## User's Manual







# Foreword

## General

This manual introduces the installation, functions and operations of the distributed play box (hereinafter referred to as "the box"). Read carefully before using the box, and keep the manual safe for future reference.

## Safety Instructions

The following signal words might appear in the manual.

Signal Words	Meaning
 <b>DANGER</b>	Indicates a high potential hazard which, if not avoided, will result in death or serious injury.
 <b>WARNING</b>	Indicates a medium or low potential hazard which, if not avoided, could result in slight or moderate injury.
 <b>CAUTION</b>	Indicates a potential risk which, if not avoided, could result in property damage, data loss, reductions in performance, or unpredictable results.
 <b>TIPS</b>	Provides methods to help you solve a problem or save time.
 <b>NOTE</b>	Provides additional information as a supplement to the text.

## Revision History

Version	Revision Content	Release Time
V1.0.2	Updated basic operations.	May 2023
V1.0.1	Updated basic operations.	August 2022
V1.0.0	First release.	April 2022

## Privacy Protection Notice

As the device user or data controller, you might collect the personal data of others such as their face, fingerprints, and license plate number. You need to be in compliance with your local privacy protection laws and regulations to protect the legitimate rights and interests of other people by implementing measures which include but are not limited: Providing clear and visible identification to inform people of the existence of the surveillance area and provide required contact information.

## About the Manual

- The manual is for reference only. Slight differences might be found between the manual and the product.

- We are not liable for losses incurred due to operating the product in ways that are not in compliance with the manual.
- The manual will be updated according to the latest laws and regulations of related jurisdictions. For detailed information, see the paper user's manual, use our CD-ROM, scan the QR code or visit our official website. The manual is for reference only. Slight differences might be found between the electronic version and the paper version.
- All designs and software are subject to change without prior written notice. Product updates might result in some differences appearing between the actual product and the manual. Please contact customer service for the latest program and supplementary documentation.
- There might be errors in the print or deviations in the description of the functions, operations and technical data. If there is any doubt or dispute, we reserve the right of final explanation.
- Upgrade the reader software or try other mainstream reader software if the manual (in PDF format) cannot be opened.
- All trademarks, registered trademarks and company names in the manual are properties of their respective owners.
- Please visit our website, contact the supplier or customer service if any problems occur while using the device.
- If there is any uncertainty or controversy, we reserve the right of final explanation.

# Important Safeguards and Warnings

This section introduces content covering the proper handling of the box, hazard prevention, and prevention of property damage. Read carefully before using the box, and comply with the guidelines when using it.

## Installation Requirements



- Improper use of the battery might result in a fire or explosion.
- Make sure to use the same model when replacing the battery.
- Use the standard power adapter. We will assume no responsibility for any problems caused by the use of a nonstandard power adapter.
- Use the power cords that are recommended for the region and conform to the rated power specifications.



- Do not place the box in a place exposed to sunlight or near heat sources.
- Keep the box away from dampness, dust, and soot.
- Install the box on a stable surface to prevent it from falling.
- Put the box in a well-ventilated place, and do not block its ventilation.
- The power supply must conform to the requirements of ES1 in IEC 62368-1 standard and be no higher than PS2. Please note that the power supply requirements are subject to the device label.
- The device is a class I electrical appliance. Make sure that the power supply of the device is connected to a power socket with protective earthing.
- The appliance coupler is a disconnection device. Keep it at a convenient angle when using it.

## Operation Requirements



- Do not drop or splash liquid onto the box, and make sure that there is no object filled with liquid on the box to prevent liquid from flowing into it.
- Operate the box within the rated range of power input and output.
- Do not disassemble the box.
- Use the box under allowed humidity and temperature conditions. Operating temperature: – 10 °C to +55 °C (14 °F to 113 °F).
- Place the device in a location that children cannot easily access.

# Contents

Foreword.....	I
Important Safeguards and Warnings.....	III
1 Introduction.....	1
2 Packing List.....	2
3 Structure.....	3
3.1 Dimensions.....	3
3.2 Ports.....	4
4 Basic Operations.....	6
4.1 Starting and Shutting Down.....	6
4.2 Initialization.....	6
4.3 Login.....	9
4.4 Resetting the Password.....	9
4.5 Changing the Password and Security Questions.....	9
4.5.1 Setting the Password Validity Period.....	10
4.5.2 Changing the Password.....	10
4.5.3 Changing Security Questions.....	11
4.6 Quick Toolbar.....	11
4.7 Releasing Projects.....	12
4.7.1 Network Release.....	12
4.7.2 Local Release.....	16
4.8 App Manager.....	25
4.8.1 Installing the App.....	26
4.8.2 File Manager.....	26
5 System Settings.....	28
5.1 Setting the Date and Time.....	28
5.2 Selecting the Input Source.....	28
5.3 Configuring Visual and Audio Parameters.....	29
5.4 System Language.....	30
6 Maintenance and Update.....	31
6.1 Maintenance Requirements.....	31
6.2 Restoring Factory Defaults.....	31
6.3 Updating the System.....	31
6.4 Configuring Automatic Maintenance Time.....	32
6.5 Turning the Screen on/off at a Fixed Time.....	32
6.6 Turning the Box On/Off at a Fixed Time.....	33
6.7 Restarting the Box.....	33

6.8 Viewing Device Information.....33  
**Appendix 1 Remote Control..... 34**  
**Appendix 2 Cybersecurity Recommendations..... 36**

# 1 Introduction

The play box is a new generation of smart cloud information terminal integrated with multimedia information release, advertisement release, and network access. Based on an industrial design scheme, it is paired with the information release management platform that features B/S architecture. The box can play images, videos, and scroll captions in both full screen or split screen. You can set multiple play modes on the platform such as loop, timed playing, inter-cut and idle-time playing for multidimensional and flexible control over the time videos are played, their sequence, content and position.

The box is highly suitable for use in residential communities, factories, schools, and more. It can also be used in various industries such as elevator, finance, catering, media, hotel, transportation, and education.

## 2 Packing List

Check whether there is any obvious damage to the package box. Unpack the box and check whether the components are complete according to the packing list.

Table 2-1 Packing list

Name	Quantity	Name	Quantity
Distributed play box	1	Power adapter	1
Remote control	1	Fixed base bracket	1
Wi-Fi antenna	1	Quick Start Guide	1



# 3 Structure

## 3.1 Dimensions

Figure 3-1 Dimensions (Unit: mm)

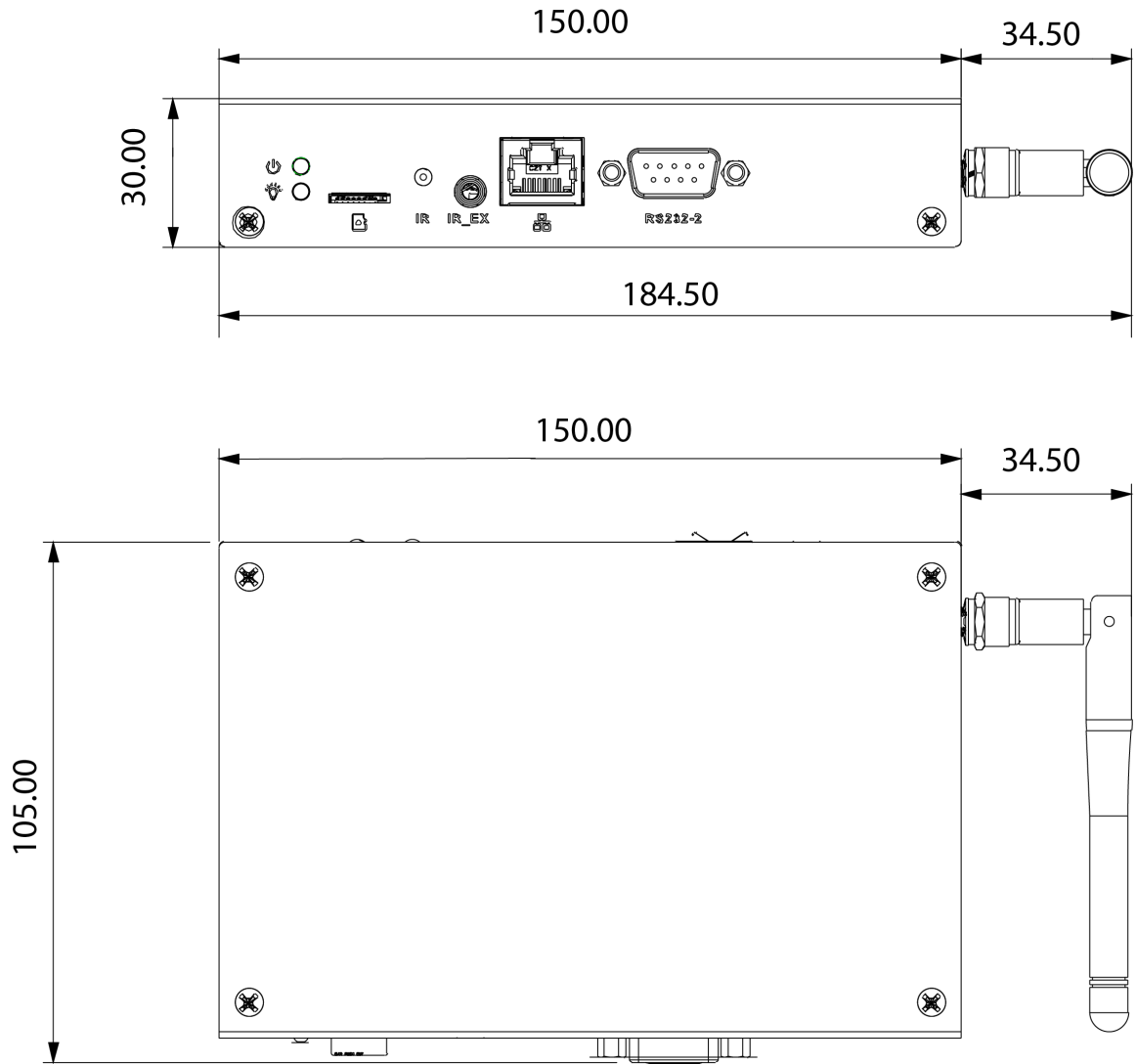

## 3.2 Ports

Figure 3-2 Ports (1)

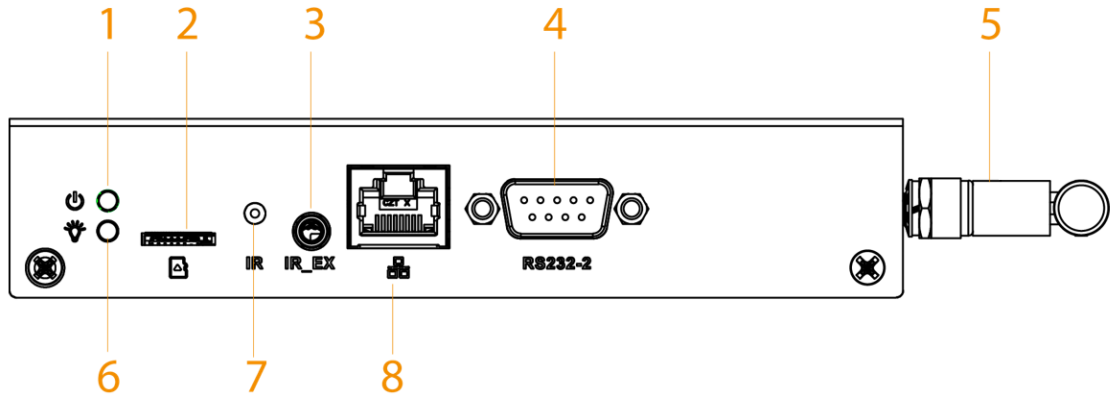

Figure 3-3 Ports (2)

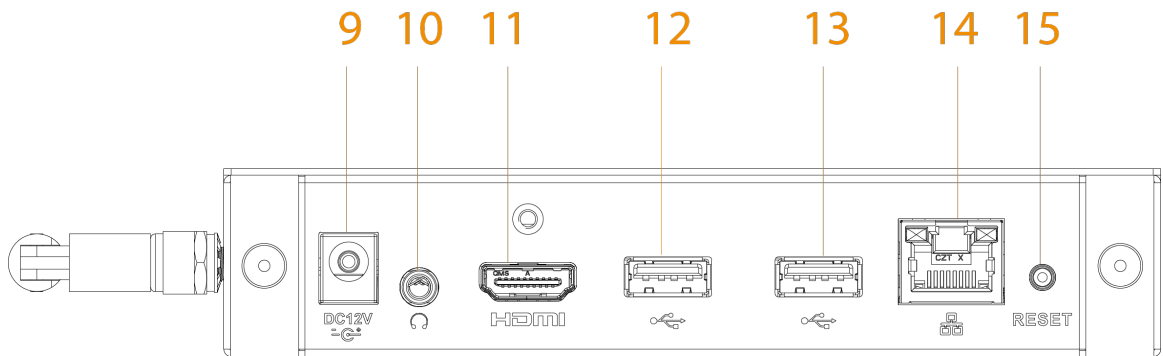



Table 3-1 Port description

No.	Name	Description
1	Power indicator light	The light turns on when the box is powered on.
2	TF card slot	<p>Insert a TF card. The TF card is used to force update the Android OS or provide media for projects. A force update is needed when the Android OS restarts repeatedly or the box cannot be started.</p> <p></p> <ul style="list-style-type: none"> <li>You cannot use the TF card to store data on the box.</li> <li>Contact the technical support if your box needs a force update.</li> </ul>
3	IREX port	Connects to the infrared extension cable.
4	RS-232 port	RS-232 serial port for communication and debugging.
5	Wi-Fi antenna	Receives Wi-Fi signals.
6	Operation status indicator light	<ul style="list-style-type: none"> <li>The light turns on when the box runs normally.</li> <li>The light flashes when the box malfunctions.</li> </ul>
7	IR port	Receives IR signals from the remote control.

No.	Name	Description
8	RS-232 port	RS-232 (in RJ-45 format) serial port for communication and debugging.
9	Power port	Connects to 12 VDC power adapter.
10	Audio jack	Connects to a 3.5 mm headphone to output audio signals.
11	HDMI port	Outputs signals to devices that support HDMI to play projects.
12	USB 2.0/OTG	Connects to the mouse, USB storage devices and other types of devices. You can switch the USB mode to OTG.
13	USB 2.0	Connects to mouse, USB storage devices and other devices.
14	Network port	Connects to the network cable.
15	Reset button	Contact customer service to use the button to restore the box to its factory settings or reset the password.

# 4 Basic Operations

The remote control supports limited operations: You can use the remote control to turn on or off the screen, turn on, turn off, or restart the box, adjust the volume and go back to the home page. We recommend you connect a mouse to operate the box. This chapter uses connecting a mouse for device operations as the example.

## 4.1 Starting and Shutting Down



- Before you start the box, check whether the input voltage matches the rated voltage of the box.
- To ensure stable operation and long service life of the box and external devices connected to the box, follow national standards and provide a power supply with stable voltage and low ripple interference.

### Starting the box

Plug in the power cord, and then turn on the switch. The box starts.

### Shutting down the box

Turn off the switch and then unplug the power cord. The box shuts down.

## 4.2 Initialization

### Background Information

When you log in for the first time or after you restore the factory settings, you need to initialize the box. After that, you can configure and operate the box.

### Procedure

- Step 1 Power on the box.
- Step 2 Select the language, and then click **Save and Next**.
- Step 3 Read the software license agreement, and then click **Next**.
- Step 4 Enter and confirm the password, and then click **OK**.

Figure 4-1 Enter password

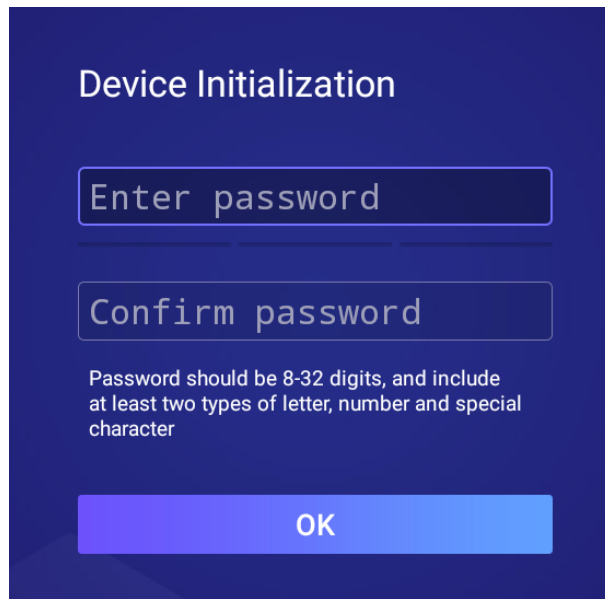

Step 5 Set your security questions.



Click **Skip** if you do not want to configure the security questions.

- a. Select the security questions and then configure the corresponding answers.
- b. Click **Save and Next**.

Figure 4-2 Password protection

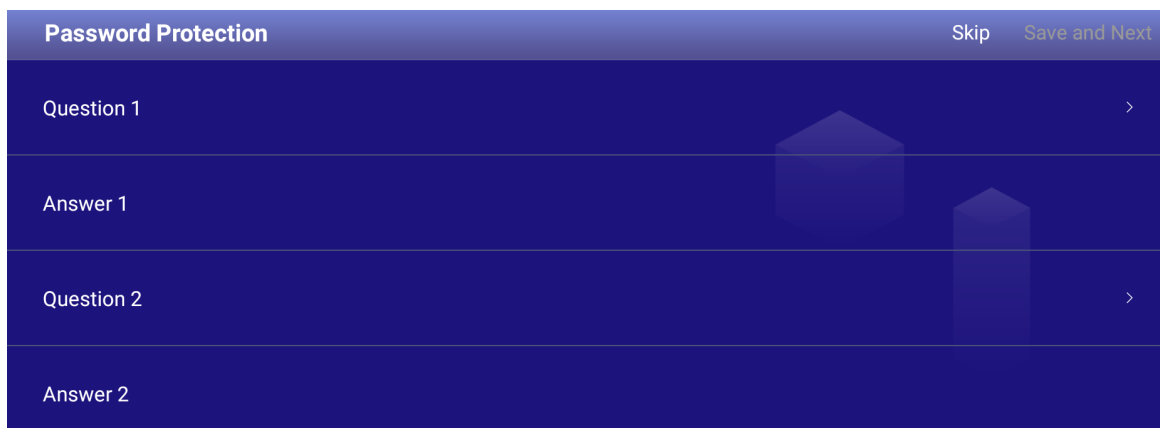

Step 6 Set the device name.

- a. Click  to set the device name.
- b. Click **Save and Next**.



Step 7 Configure network settings.



Click **Skip** if you do not want to configure the network settings.

- a. Select a network type and then configure network settings.

Table 4-1 Network settings

Network type	Description
WLAN	<p>Click  when Wi-Fi is available near the box.</p> <ul style="list-style-type: none"> <li>• Auto search: Click a Wi-Fi network, enter its password, and then click <b>Connect</b>.</li> <li>• Connect to the Wi-Fi manually: Click , and then on the <b>Add network</b> page, enter network SSID, select a security option, and then click <b>Save</b>.</li> </ul> <p></p> <p>We recommend you choose a secure authentication method to connect to the Wi-Fi.</p>
Ethernet	<p>Connect the box to the network by Ethernet. There are 2 methods to set the IP address of the box.</p> <ul style="list-style-type: none"> <li>• DHCP: When there is a DHCP server on the network, select <b>DHCP</b> to allow the box to get an IP address from the DHCP server automatically.</li> <li>• Static IP: After you select <b>Static IP</b>, configure <b>IP Address</b>, <b>Gateway</b>, and <b>Netmask</b> according to your network plan.</li> </ul>

b. Click **Save and Next**.

**Step 8** Register the box to the platform.



Click **Skip** to skip platform registration.

a. Enter the IP address or domain name, port of the platform (MPS or ICC), and the department ID.

Figure 4-3 Platform registration

b. Click **Complete**.

## 4.3 Login

### Background Information

You need to log in to the system to perform operations when any of the following situations occurs.

- It is your first-time use after initialization.
- You locked the screen manually.
- The screen locked the screen automatically after a long period of inactivity.

### Procedure

Step 1 Click any position on the screen.

Step 2 Enter the password, and then click **OK**.

The home page or the page that was open before the screen is locked is displayed.



After 5 consecutive failed login attempts, the system will prompt **Account locked, restart or try again 5 minutes later**.

## 4.4 Resetting the Password

### Procedure

Step 1 On the login page, click **Forgot Password**.

Step 2 Enter answers to all the security questions.

Step 3 Click **Confirm**, enter the new password and then confirm it.

Figure 4-4 Verify security questions

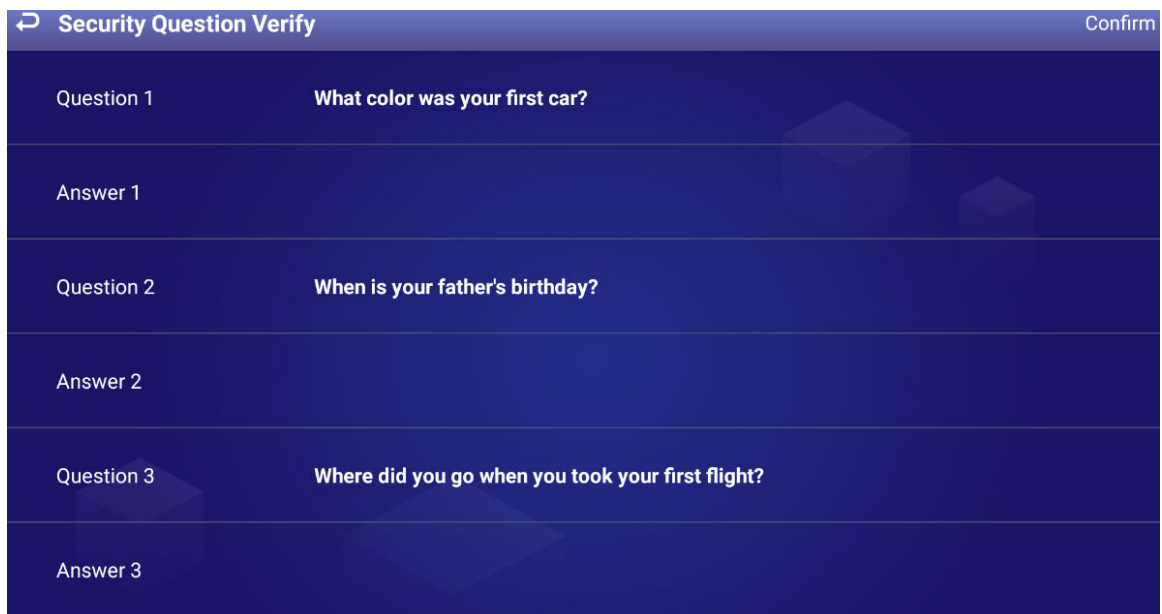

Question	Answer
Question 1	Answer 1
Question 2	Answer 2
Question 3	Answer 3

## 4.5 Changing the Password and Security Questions

We recommend changing the login password and security questions regularly to keep the box safe.

## 4.5.1 Setting the Password Validity Period

### Procedure

- Step 1 On the home page, select **Settings** > **Password Setting** > **Password Validity Period Setting** .

Figure 4-5 Password validity period setting

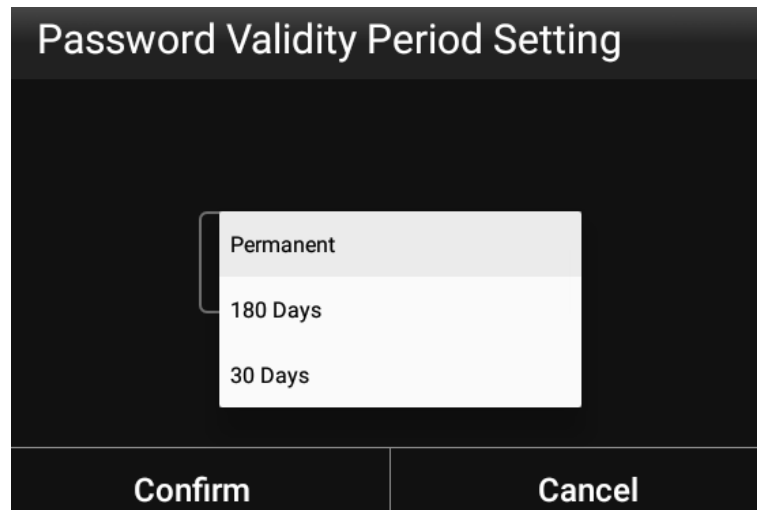

- Step 2 Select a password validity period. **Permanent** is selected by default.
- Step 3 Click **Confirm**.
- Step 4 (Optional) If the password remains unchanged after the validity period expires, the system will prompt you to change the password. Click **Modify** to change the password immediately; click **Not Now** to log in without changing the password.

## 4.5.2 Changing the Password

### Procedure

- Step 1 On the home page, select **Settings** > **Password Setting** > **Password Setting** .
- Step 2 Enter old password and new password, and then confirm your new password.
- Step 3 Click **Save**.

Figure 4-6 Password settings

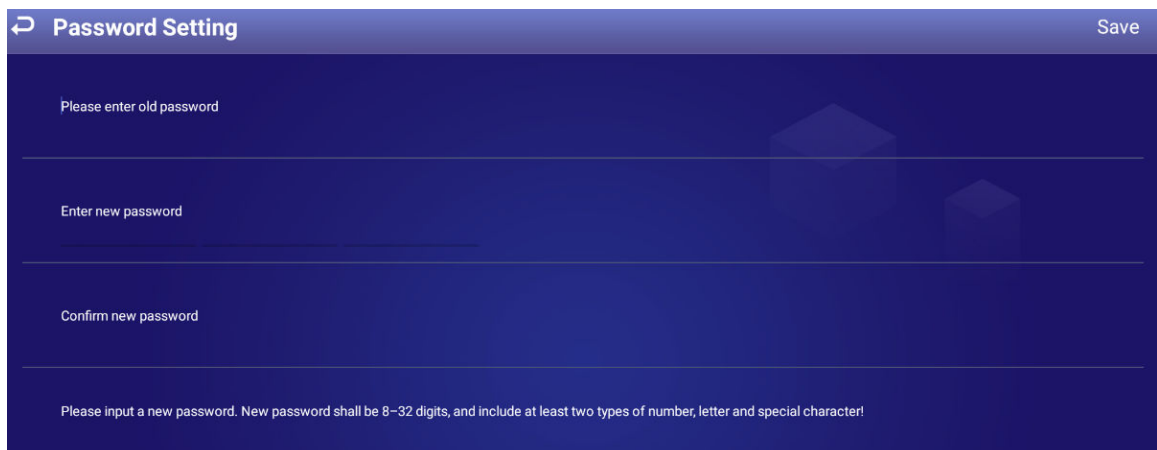



## 4.5.3 Changing Security Questions

### Procedure

Step 1 On the home page, select **Settings** > **Password Setting** > **Modify Security Question** .

Figure 4-7 Modify security question

Step 2 Change answers to the security questions.



To change your security questions, correctly answer the questions, click **Clear**, and then set them up again.

Step 3 Click **Setting**.

## 4.6 Quick Toolbar



The quick toolbar can help to improve your operation efficiency.





Point to the bottom of the page, and then the quick toolbar is displayed.

Figure 4-8 Quick toolbar



Table 4-2 Description of quick toolbar

Icon	Description
	Indicates whether the box is registered to the platform.
	Go to the home page.

Icon	Description
	Adjust volume.
	Adjust backlight brightness.
	Lock the screen.
	Disconnect your USB drive from the box.

## 4.7 Releasing Projects

You can release projects locally or through the platform.

### 4.7.1 Network Release

Release projects through the network. Register the box to the platform when you use network release for the first time.

#### 4.7.1.1 Configuration Flow of Network Release

Figure 4-9 Network release



Table 4-3 Configuration flow of network release

Operation	Description
Log in	Log in and configure the box. For details, see "4.3 Login".
Configure network	Connects the box to the network. For details, see "4.7.1.2 Configuring the Network".
Register the box to the platform	After registering the box to the platform, you can release projects and operate the box through the platform. For details, see "4.7.1.3 Registering the Box to the Platform".
Release project through the platform	After you add media and configure project plans on the platform, you can play projects on the box. For details, see the user's manual of the platform.

## 4.7.1.2 Configuring the Network

### 4.7.1.2.1 Connecting the Box to the Network

Connect your box to the network by Ethernet or WLAN. Also, once connected, it can be used as a hotspot for other devices.

#### Procedure

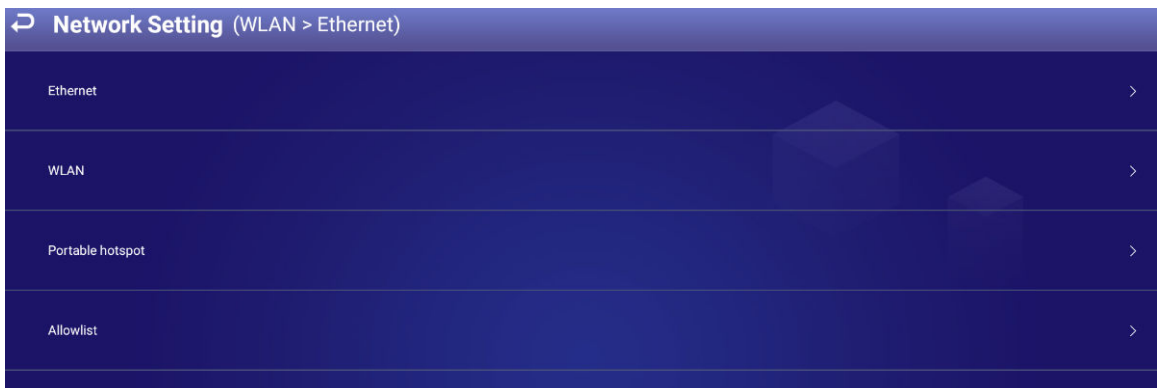

**Step 1** On the home page, select **Settings > Network Setting**.

Figure 4-10 Network setting



**Step 2** Configure the network type that you want to use.

Table 4-4 Configure network

Network Type	Description
Ethernet	<p>Connect your box to the network by Ethernet. There are 2 methods to plan the IP.</p> <ul style="list-style-type: none"><li>● DHCP: When there is a DHCP server on the network, after selecting the DHCP option, the box automatically obtains the IP address from the DHCP server.</li><li>● Static IP: After you select <b>Static IP</b>, set the IP address, default gateway and net mask manually according to the network plan.</li></ul>
WLAN	<p>Click  if Wi-Fi is available near the box. After you turn on this function, connect your box to the Wi-Fi using either of the following methods.</p> <ul style="list-style-type: none"><li>● Auto search: Click a Wi-Fi network, enter its password, and then click <b>Connect</b>.</li><li>● Connecting to Wi-Fi manually: Click , and the <b>Add Network</b> page is displayed. Enter <b>Network SSID</b>, select a security option, and then click <b>Save</b>.</li></ul>
Portable hotspot	<p>On the home page, select <b>Settings &gt; Network Setting &gt; Portable Hotspot</b>, and enable <b>Portable Hotspot</b>, then you can use your box as a hotspot for other devices.</p>

### 4.7.1.2.2 Configuring the Allowlist

Configure IP addresses that are allowed to access the box. Only IP addresses on the allowlist can be used to log in to the web interface. This is to enhance data security.

#### Procedure

Step 1 On the home page, select **Settings > Network Setting > Allowlist** .

Step 2 Click  to enable the allowlist.

Step 3 Add the IP address of the target device to the allowlist.

1. Click .

Figure 4-11 Add allowlist

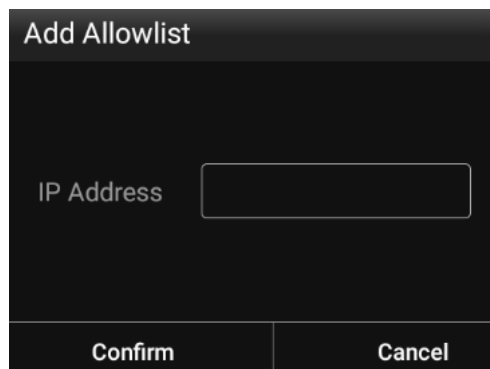

2. Enter an IP address.
3. Click **Confirm**.



You can add multiple IP addresses to your allowlist.

### 4.7.1.3 Registering the Box to the Platform

Register the box to the platform, and then you can release projects through the platform and play the projects on the box.

#### Prerequisites

- The box and the platform are connected to the same network. To connect the box and the platform to the network, see "4.7.1.2.1 Connecting the Box to the Network".
- If allowlist is enabled, make sure that the IP address of the platform is added to the allowlist. For allowlist configuration, see "4.7.1.2.2 Configuring the Allowlist".

#### Procedure

Step 1 On the home page, click **Network Release**.

Figure 4-12 Network release

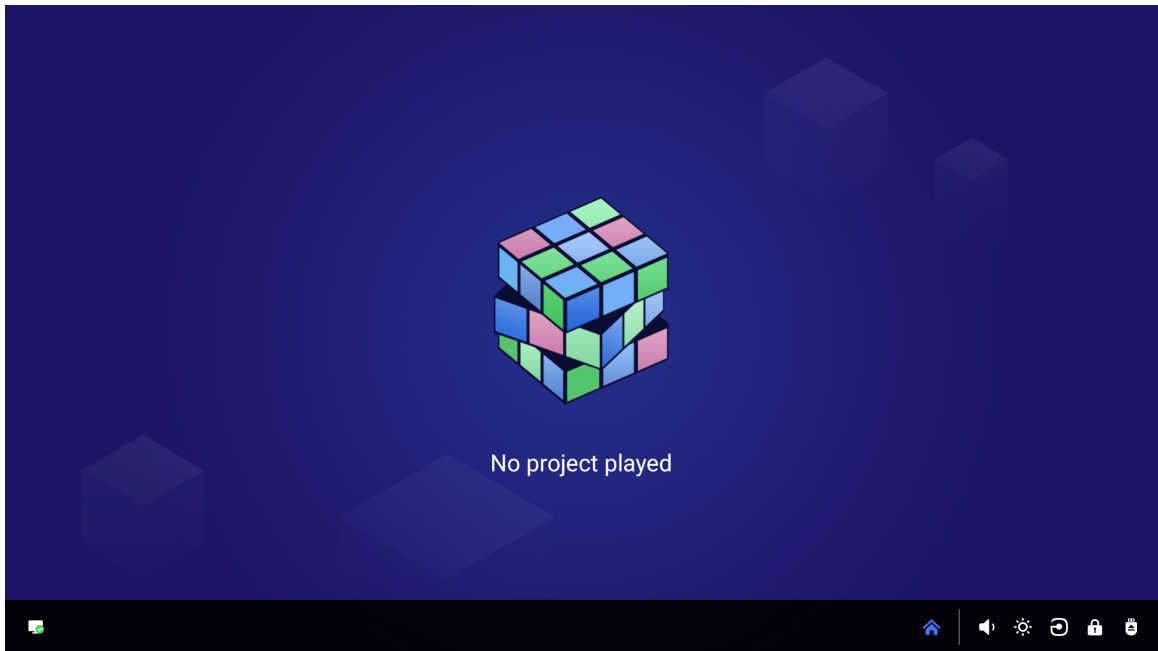

Step 2 Click  on the lower-left corner.

Figure 4-13 Platform address

A screenshot of a "Platform Registration" dialog box. The title "Platform Registration" is at the top in white. Below the title are three input fields: the first is labeled "Please enter IP or domain name", the second contains the number "8682", and the third is labeled "Please enter department ID". At the bottom of the dialog is a large blue button with the text "OK" in white.

Step 3 Enter the IP address or domain name of the platform (MPS or ICC), the platform port and the ID of the department that the box is in.



After registration, you can only link the box with devices in the same department. For details on performing operations on the platform, see the corresponding user's manual.

Step 4 Click **OK**.

After successful registration, the icon on the lower-right corner changes to .

## 4.7.2 Local Release

Add videos or pictures to projects, and release projects locally by using **General** or **Special** template.

### 4.7.2.1 Configuration Flow of Local Release

For **General** template, you can select **Quick Play** and **Customized Play**.

For **Special** templates, you can select from **Catering & Life**, **Special Offer & Promotion**, **Brand Publicity**, **Supermarket & Hotel**, **Info & News**, **Face Attendance**, **Stream Media**, and **Video Surveillance**.

Figure 4-14 Local release (general template)

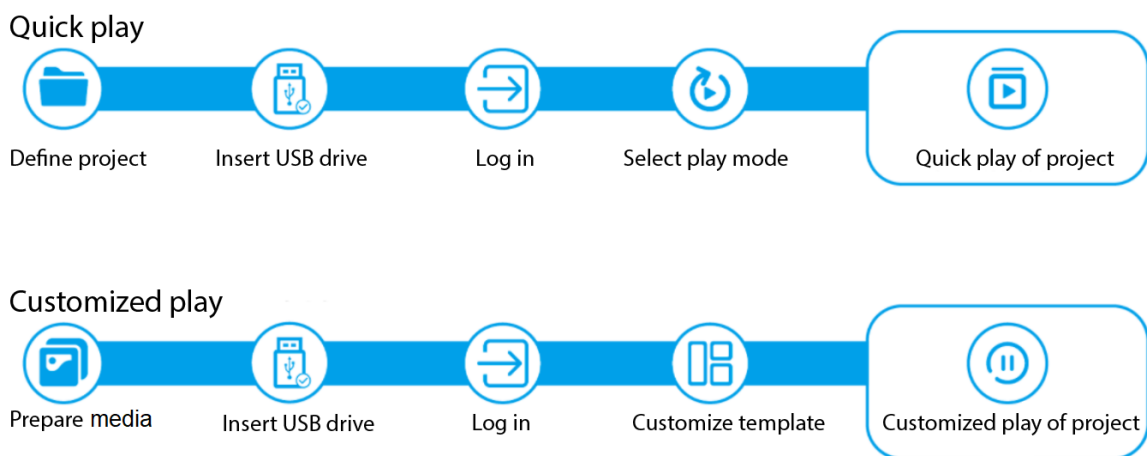
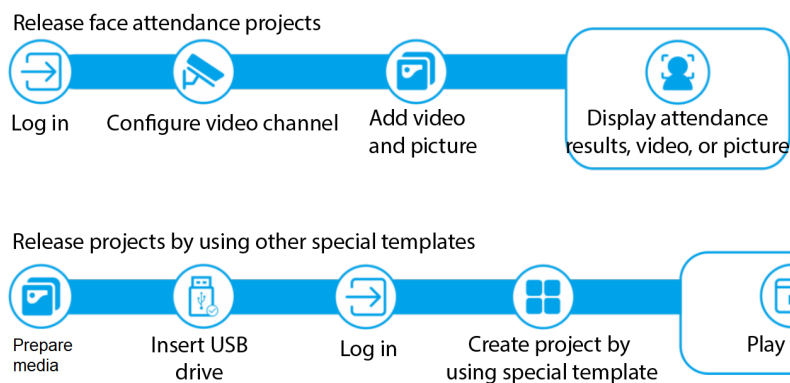

Figure 4-15 Local release (special template)



### 4.7.2.2 Releasing Projects by General Templates

#### 4.7.2.2.1 Quick Play

Use the given templates to quickly release projects.

#### Procedure

- Step 1** Connect the USB drive to your computer, create a folder named USBPLAY on the USB drive, and then save your media to the folder, such as videos, pictures, audio, and PDF files.

Step 2 Insert the USB drive into the box.

Step 3 On the home page, select **Local Release** > **General** > **Quick Play** .

Figure 4-16 Quick play

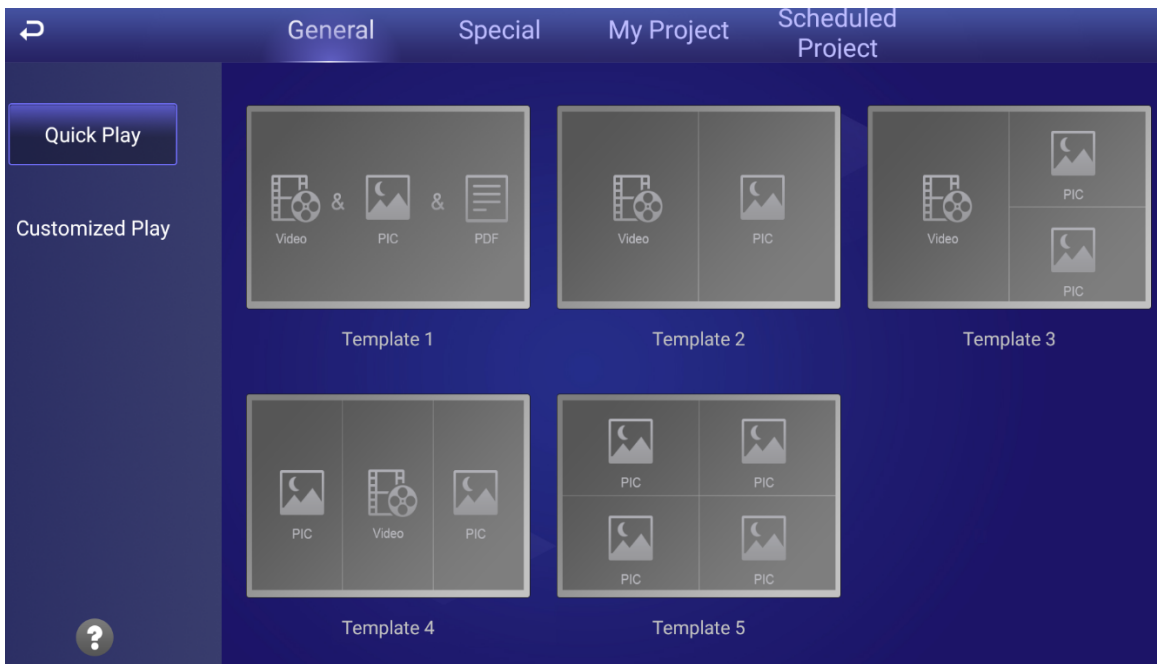

Step 4 Select a template.

The system will display the media in the USBPLAY folder. A picture is displayed for 10 seconds by default and a video to its end.



PDF files can be imported only to **Template 1**.

#### 4.7.2.2.2 Custom Play

Define your own templates to release information.

#### Procedure

Step 1 On the home page, select **Local Release** > **General** > **Customized Play** .

Figure 4-17 Customized play



**Step 2** Click a template and then define the template.

1. Click 

Figure 4-18 Add media

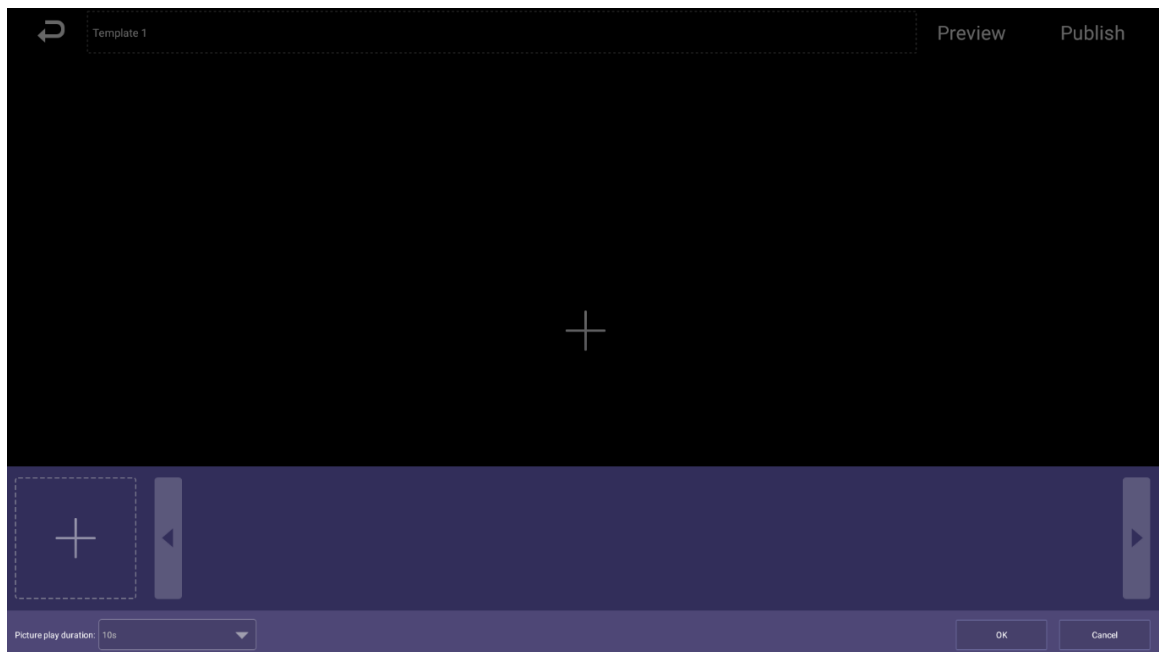

2. Click , select media content, and then configure the picture play duration.



- Pictures are displayed for 10 seconds by default and videos to their end.
- You can upload multiple media contents and then drag the media to sort them.
- Click  to delete the media.

3. Click **OK**.



Step 3 Click **Preview** on the upper-right corner to preview the project to be played.

Step 4 Click **Publish** on the upper-right corner to play your project immediately.

### 4.7.2.3 Releasing Projects by Special Templates

**Special** templates include **Catering & Life** , **Special Offer & Promotion** , **Brand Publicity** , **Supermarket & Hotel** , **Info & News** , **Face Attendance** , **Stream Media** , and **Video Surveillance**. Select a template as needed.

#### 4.7.2.3.1 Configuring the Face Attendance Template

Add a camera channel to the box, and then the face information captured by the camera will be displayed, such as the capture time and the similarity between the faces captured and faces saved in the database.

#### Prerequisites

- When connecting your camera and the box through the DSS or PSS protocol, make sure that a registration code is assigned to the box by the DSS platform or the Smart PSS Plus client.
- The box, your camera, and the platform (for example DSS) are connected to the same LAN (Local Area Network).
- Your camera supports face detection and face comparison, and face database is configured.

#### Procedure

Step 1 On the home page, select **Local Release** > **Special** .

Step 2 Click the **Face Attendance** template.

Figure 4-19 Configure face attendance template

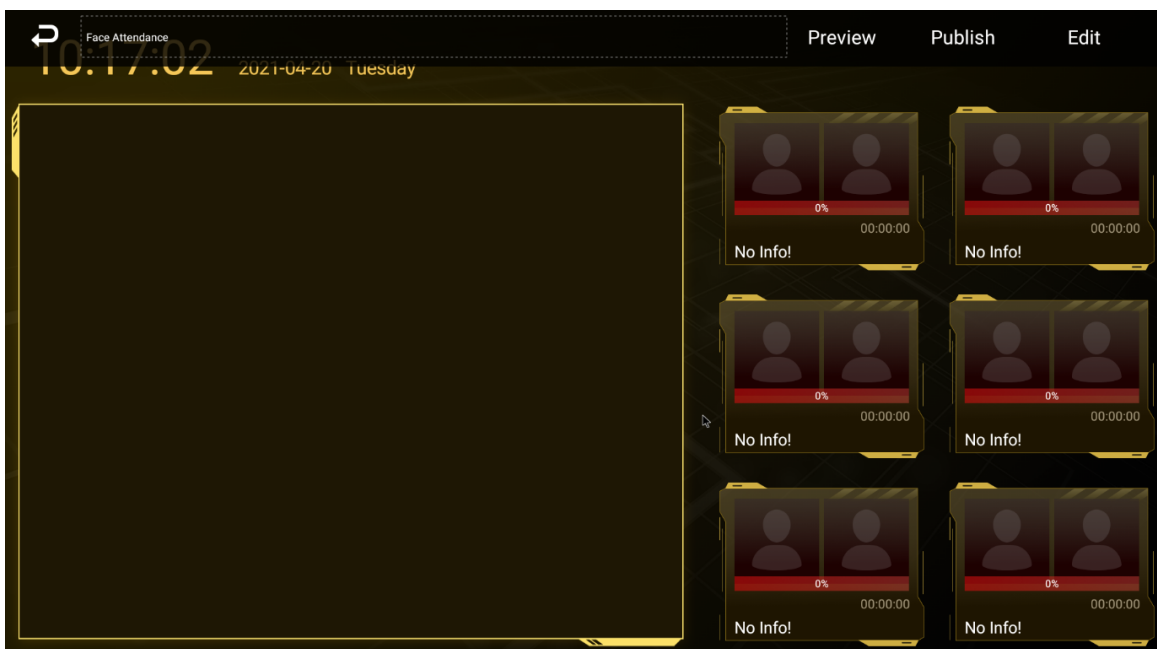

Step 3 Click **Edit** on the upper-right corner.

Figure 4-20 Setting

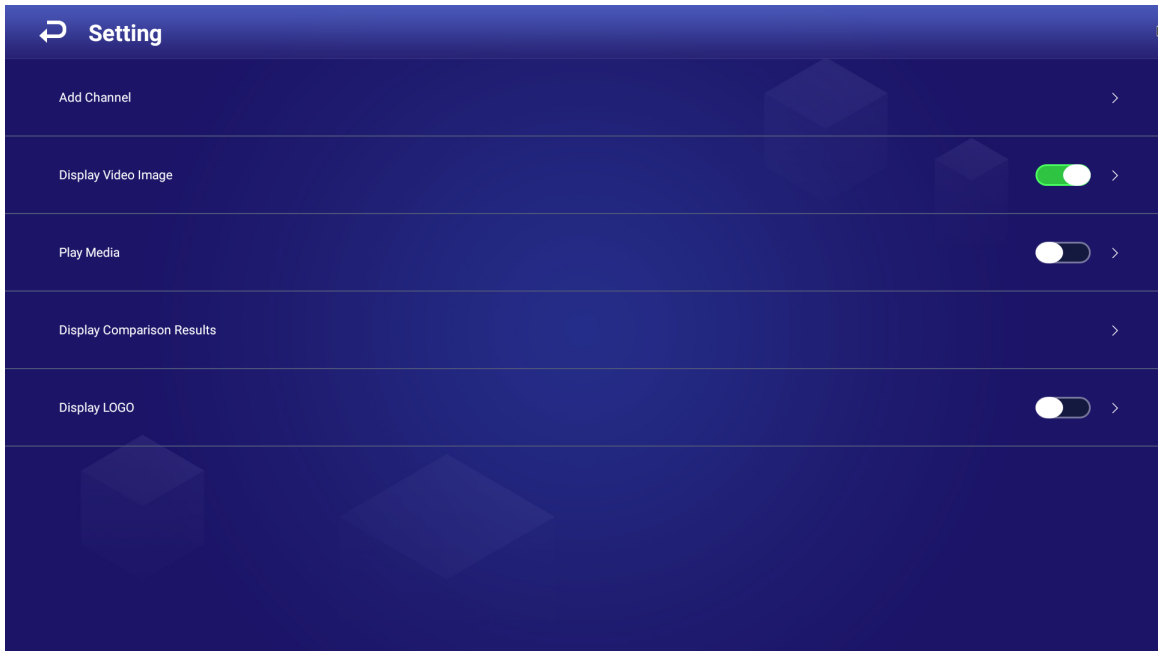

1. Click **Add Channel**.



Figure 4-21 Add channel

A screenshot of a dark-themed "Add Channel" dialog box. It contains the following fields: "Protocol" (dropdown menu showing "Acquisition"), "IP Address" (text input), "Username" (text input), "Password" (text input), "Port" (text input), "Channel" (text input), and "Stream Type" (dropdown menu showing "Main Stream"). At the bottom are two buttons: "Confirm" and "Cancel".

2. Configure the parameters.

Table 4-5 Description of adding channel



Parameter	Description
Protocol	Select a protocol depending on the device or platform that is connected.









Parameter	Description
	<ul style="list-style-type: none"> <li>When the box is connected to IVSS (intelligent video surveillance server) or IP camera, select <b>Acquisition</b>.</li> <li>When the box is connected to SmartPSS, select <b>PSS</b>.</li> <li>When the box is connected to DSS, select <b>DSS</b>.</li> </ul>
IP Address	<p>Enter the IP address of the IP camera, IVSS, DSS, or PSS, depending on the <b>Protocol</b> that you select.</p>  <p>You can add up to 8 <b>Acquisition</b> channels. 1 <b>DSS</b> channel, and 1 <b>PSS</b> channel. The channels must not conflict with each other.</p>
Port	Port for logging in to the IP camera, IVSS, DSS, or PSS. It is 37777 by default for the IP camera and IVSS, and 8101 for DSS and PSS.
Channel	<p>You need to enter channel No. when IP camera or IVSS is connected.</p> <ul style="list-style-type: none"> <li>Enter 1 when IP camera is connected.</li> <li>Enter the channel No. assigned by IVSS when IVSS is connected.</li> </ul>
Username	Username and password for logging in to the IP camera or IVSS.
Password	 <p>You need to enter the username and password when <b>Acquisition</b> is selected in <b>Protocol</b>.</p>
Stream Type	<ul style="list-style-type: none"> <li>Main stream: Provides large bit stream and images with high resolution, but requires large amount of bandwidth.</li> <li>Sub stream: Sub stream 1 or sub stream 2 are available. Provides small bit stream and a smooth image, and requires less bandwidth.</li> </ul>

3. Click **Confirm**.

**Step 4** Configure other parameters.

Table 4-6 Description of other parameters

Parameter	Description
Display Video Image	<ul style="list-style-type: none"> <li><b>Screen split</b>: You can view the video image of the added channels by 1, 2, 3, or 4 splits.</li> <li><b>Switching time(seconds)</b>: Switch to play the video of another added channel after the defined time.</li> <li><b>Channel selection</b>: Select the channel to be played in each screen split.</li> </ul>
Play Media	<p>Click  to add media (video or picture).</p> <ul style="list-style-type: none"> <li>Select media, and then click  to delete it.</li> <li>Drag the media to sort them.</li> <li>Pictures are displayed for 10 seconds by default and videos to their end.</li> </ul>

Parameter	Description
	 <p>Only one kind of media can be played at a time.</p>
Display Comparison Results	<p>Enable or disable voice broadcast and temperature information and display face comparison results.</p> <ul style="list-style-type: none"> <li>• Voice broadcast: Click  to enable voice broadcast.             <p>The prompt that you customize manually does not support voice broadcast.</p> </li> <li>• Display successful comparison results: Click , and then select or customize the prompt to be displayed when face comparison is successful.</li> <li>• Display failed comparison results: Click , and then select or customize the prompt to be displayed when face comparison fails.</li> <li>• Temperature: Click  to enable temperature.             <p>The temperature function is available only when the box is associated with the turnstiles from the same manufacturer.</p> </li> </ul>
Display LOGO	<p>Click  to add a picture, which will be the logo displayed on the upper-right corner when a face attendance project is played.</p>  <p>The uploaded picture must be a .png file with a transparent background. The picture must be within 430 pixels in width and 80 pixels in height.</p>

Step 5 Click **Preview** on the upper-right corner to preview the project to be played.

Step 6 Click **Publish** on the upper-right corner to play your project immediately.

#### 4.7.2.3.2 Configuring Other Special Templates

The other special templates are similar in configurations. This sections uses the supermarket & hotel template as an example.

#### Procedure

Step 1 On the home page, select **Local Release** > **Special** .

Step 2 Click a template that you want to define.

Step 3 Configure the template.

1. Click 

Figure 4-22 Add media

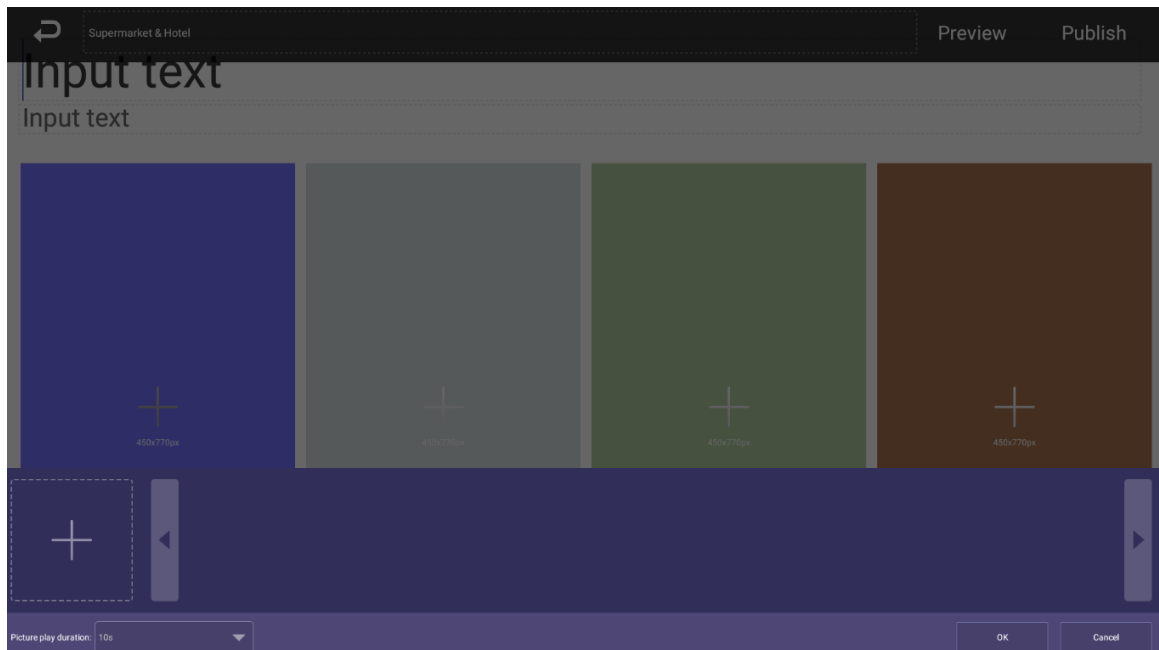

2. Click , select media content, and then configure the picture play duration.



- Pictures are displayed for 10 seconds by default and videos to their end.
- You can upload multiple media contents. After adding the media, you can drag the media to sort them.
- Click  to delete the media.

3. Click **OK**.

Step 4 Click **Preview** on the upper-right corner to preview the project to be played.

Step 5 Click **Publish** on the upper-right corner to play your project immediately.



To use a special template exported from the platform, create a folder named **TEMPLAT** on the USB drive, export a template from the platform to the folder and then import the template to the box.

#### 4.7.2.4 Managing My Project

On the home page, select **Local Release** > **My Project**, and then you can:

- View played projects and saved templates.
- Click a project to play it.
- Click , and then select a project to delete the project.

Figure 4-23 My project



#### 4.7.2.5 Scheduled Project

Configure which and when projects will be played.

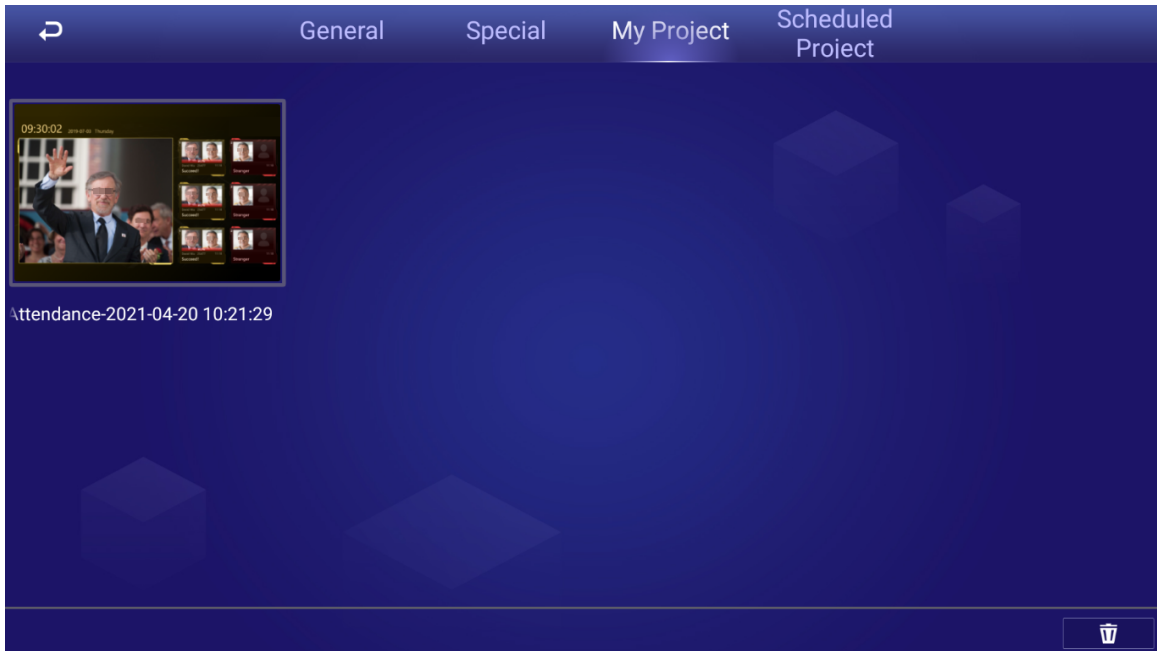
##### Procedure

Step 1 On the home page, select **Local Release** > **Scheduled Project**.

Step 2 Click , and then on the page displayed, click **Add order play period**.

Figure 4-24 Add order play period



Step 3 Set the time period, and then click .

Figure 4-25 Add order play period



Step 4 Click , select a project, and then click **OK**.

Figure 4-26 Add project



**Step 5** Click **Save**.

The system goes back to the **Add order play period** page.

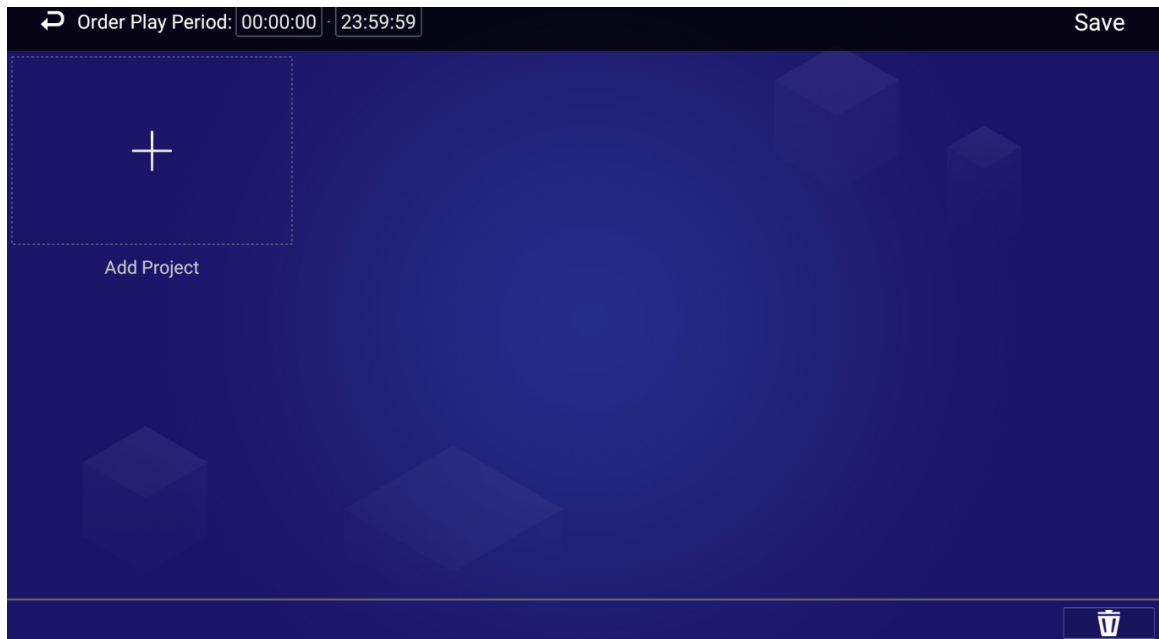

- Repeat Step 2–Step 4 to add multiple order play periods.
- Up to 30 periods can be added.

**Step 6** Click **Save**.

**Step 7** Click **Publish**. The box will play the projects according to the defined schedule.

## Related Operations

- Click  to import project schedule.

Create a folder named DAILYPLAN on the USB drive first, export the schedule from the platform to the folder, and then import the schedule to the box.

- Select a project, and then click  to delete it.

## 4.8 App Manager

On the home page, click **App Manager**, and then the **App Center** page is displayed.

You can:

- Click **App Center** to install new apps, view and manage different files, and search online.
  - ◇ Click **Install App** to install new apps.
  - ◇ Click **File Manager** to view and manage different files.
  - ◇ Connect the box to the network, and then click **Browser** to perform an online search.
- Click the **App Uninstall** tab to uninstall the app from the box.
- Click the **Boot App** tab to select the pre-installed application that runs automatically when the box starts.

Figure 4-27 App center

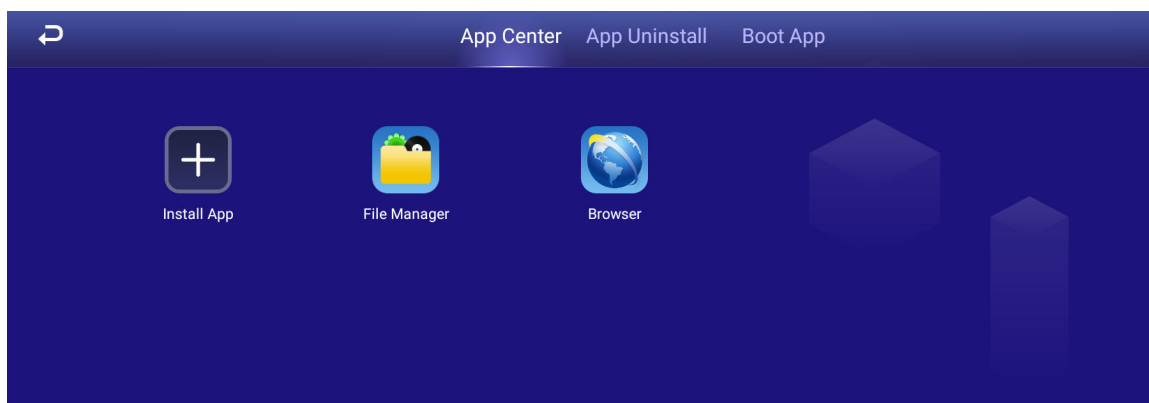

## 4.8.1 Installing the App

Install an app on the box, and then you can manage and operate the app.

### Prerequisites

Insert the USB drive with the installation package (.apk) into the box.

### Procedure

- Step 1 On the home page, select **App Manager** > **App Center** .
- Step 2 Click **Install App**.
- Step 3 Click the USB where the installation file is installed.
- Step 4 Click the installation file.
- Step 5 Click **OK**.

The installation starts. Follow the onscreen instructions to finish the installation. You can view and use the app you have installed in **App Center**.

## 4.8.2 File Manager

View and manage different types of files.

### Procedure

- Step 1 On the home page, select **App Manager** > **App Center** .
- Step 2 Click **File Manager**.

Figure 4-28 File manager

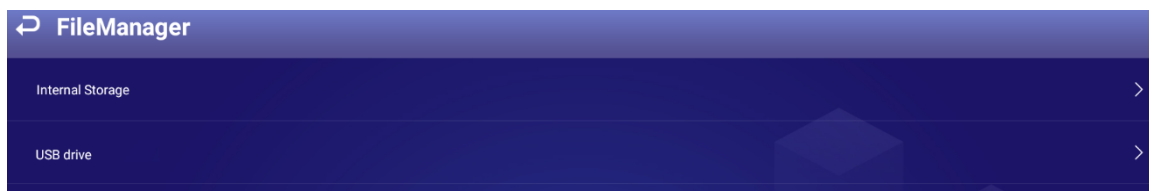

- Step 3 Select a storage path, for example, internal storage.  
The files appear under their file types. Click a file type to view and manage files.



Figure 4-29 Different types of files

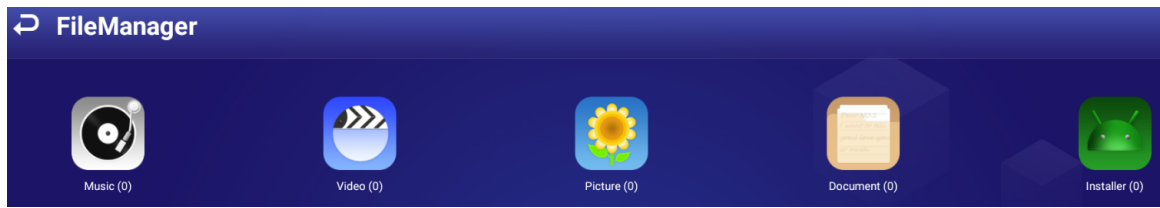

# 5 System Settings

## 5.1 Setting the Date and Time

You can set time and date for the box. Remember to select a correct time zone based on where the box lies.

### Procedure

**Step 1** On the home page, select **Settings** > **Date & Time** .

Figure 5-1 Date & time

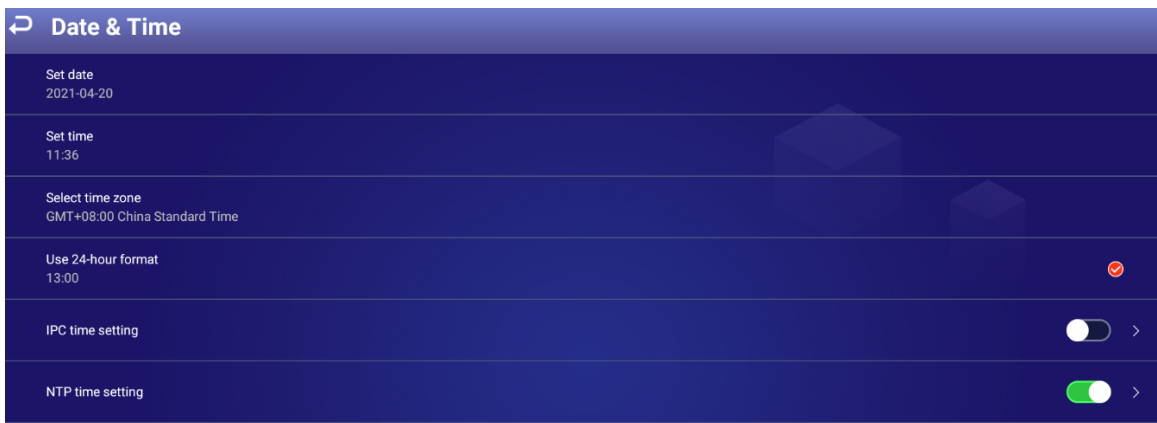

**Step 2** Set date, time, and time zone. You can also enable the 24-hour format.

**Step 3** Enable IPC time setting, configure the **Renewal cycle** (24 hours by default), and then click **Save**.

The time of IPC will be synchronized with that of the box within the defined renewal cycle.

**Step 4** Enable NTP time setting, configure the **Renewal cycle** , and then click **Save**.

The time of the box will be synchronized with that of the NTP server within the defined renewal cycle.

## 5.2 Selecting the Input Source

### Background Information

Input sources include **Local** (default) and **HDMI**.

- **Local** : Play projects from your USB drive or through the platform.
- **HDMI** : Play projects from the HDMI input source, for example, your computer.

Figure 5-2 Input source

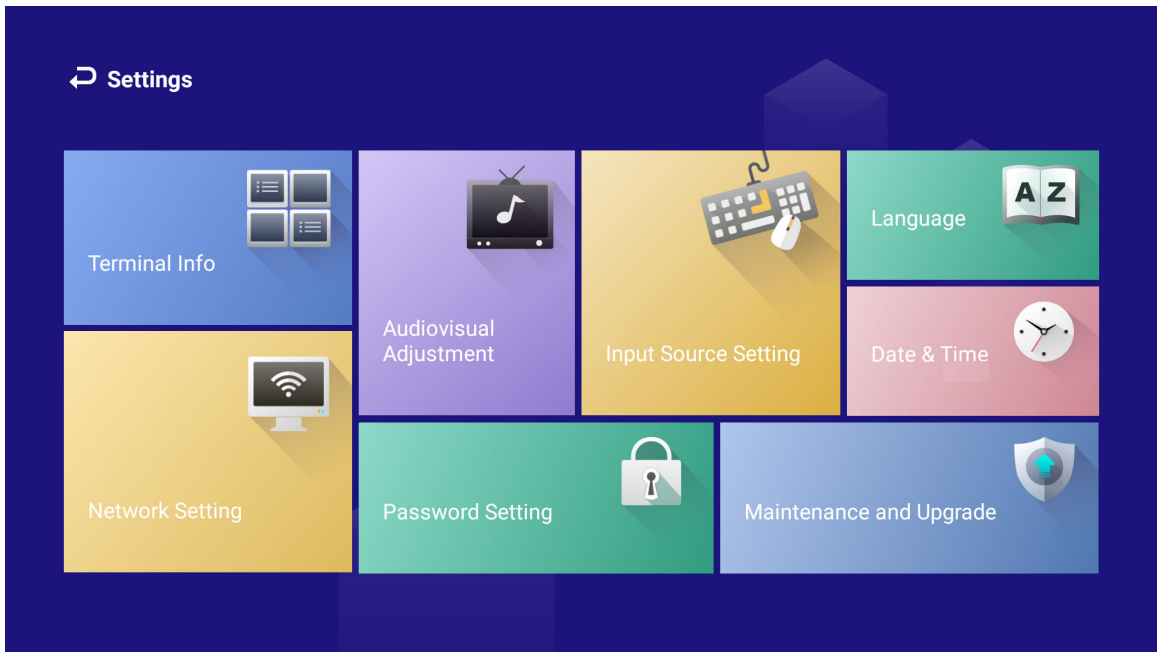

When the box itself acts as the signal input source that outputs signals through the HDMI port, **Input Source Setting** is not available.

## 5.3 Configuring Visual and Audio Parameters

Adjust display effect of screen and device volume.



If it prompts **This operation may cause power increase. Do you want to continue?**, click **Confirm** to continue.

### Procedure



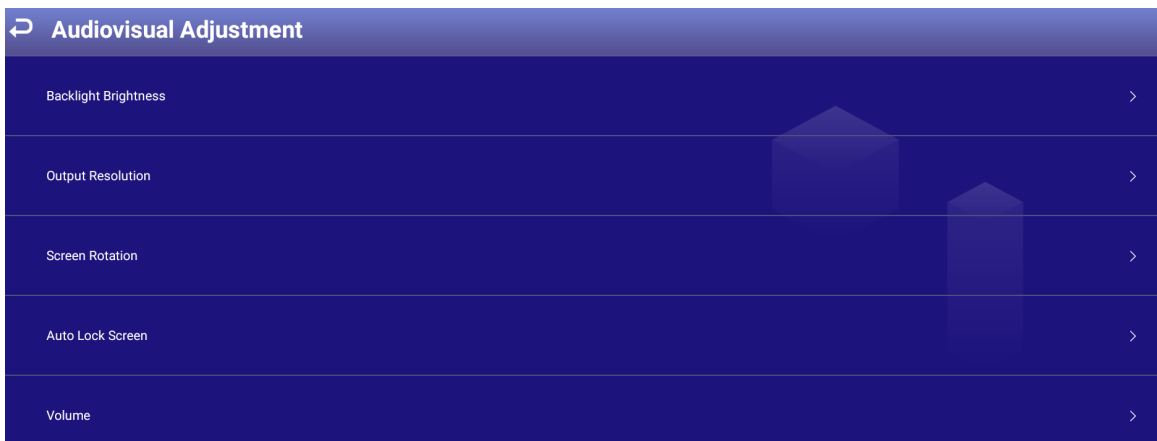

Step 1 On the home page, select **Settings** > **Audiovisual Adjustment**.

Figure 5-3 Audiovisual adjustment



Step 2 Configure visual and audio parameters.

Table 5-1 Visual & audio adjustment

Item	Description
Backlight Brightness	<p>Adjust the screen background brightness manually or automatically.</p>  <ul style="list-style-type: none"> <li>• Automatic background brightness adjustment is available on select models.</li> <li>• Click  to restore the default backlight brightness.</li> </ul>
Output Resolution	The resolution is self-adaptive by default. You can change the output resolution. The box supports 4K resolution at different frequencies.
Screen Rotation	Click <b>Screen Rotation</b> and then select an angle by which the screen rotates.
Auto Lock Screen	Set the period of inactivity after which the box locks the screen automatically.
Volume	<p>Adjust the volume of playing projects.</p>  <p>Click  to restore the default volume.</p>

## 5.4 System Language

### Procedure

Step 1 On the home page, select **Settings** > **Language** .

Figure 5-4 Language

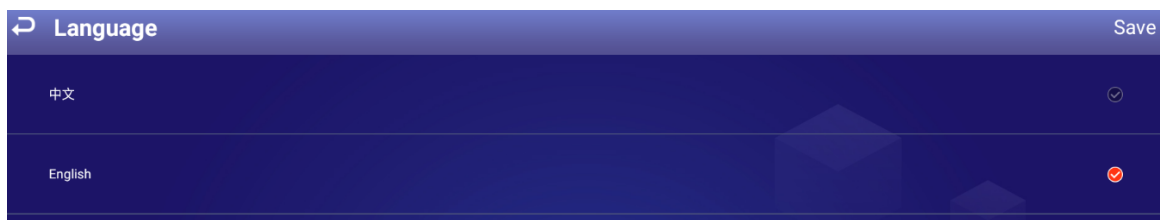

Step 2 Select a language.

Step 3 Click **Save**.

# 6 Maintenance and Update

## 6.1 Maintenance Requirements

To keep the box running normally, you need to:

- Change the user password every three months.
- Restart the box regularly.
- Update firmware regularly.

## 6.2 Restoring Factory Defaults

Restore the box to factory settings to handle problems such as storage insufficiency and system error.



Please be advised that factory resetting might cause data loss.

### Procedure

Step 1 On the home page, select **Settings > Maintenance and Upgrade > Restore Factory Defaults** .

Step 2 Click **Confirm**.

After restoring factory defaults, the box will restart.

## 6.3 Updating the System

Update system software.

### Prerequisites

Insert a USB drive with the update package into your box. Contact our customer service to get an update package.



Please be advised that downgrading to a lower version will make the box vulnerable to security attacks.

### Procedure

Step 1 On the home page, select **Settings > Maintenance and Upgrade** .

Step 2 Click **System Upgrade**.

Step 3 Select an update package to start update.

After updated, the box restarts.

## 6.4 Configuring Automatic Maintenance Time

By default, the box automatically restarts at 1:00 a.m. every day. You can customize the automatic restart time for the box.

### Procedure

- Step 1 On the home page, select **Settings > Maintenance and Upgrade > Auto Maintenance Time Setting**.

Figure 6-1 Configure auto maintenance time

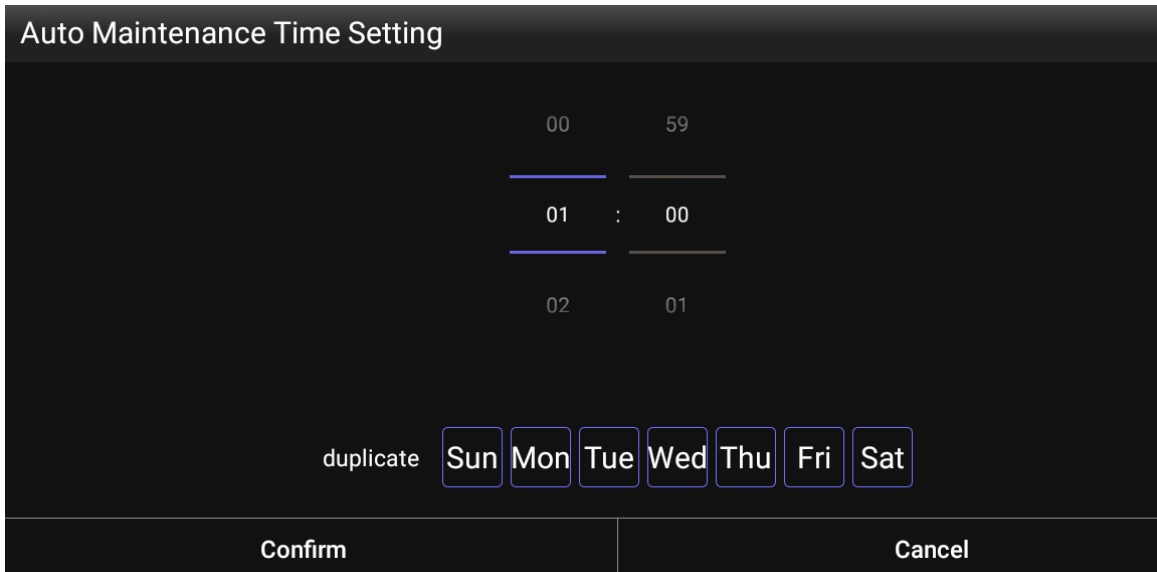

- Step 2 Drag your mouse up and down to select a time.
- Step 3 (Optional) Select the days of the week to which you want to apply the automatic maintenance time.
- Step 4 Click **Confirm**.
- Step 5 Click any position out of the **Auto Maintenance Time Setting** page to finish configuration.

## 6.5 Turning the Screen on/off at a Fixed Time

### Procedure

- Step 1 On the home page, select **Settings > Maintenance and Upgrade > Timing Screen Turn On**.

- Step 2 Click  to enable turning on or off screen by week or at a customized time.



**Custom** settings come first when **Custom** and **Week** are enabled at the same time.

- Step 3 Click  to configure the specific date and time.

- Step 4 Click **Save**.

## 6.6 Turning the Box On/Off at a Fixed Time



This function is available on select models.

### Procedure

Step 1 On the home page, select **Settings** > **Maintenance and Upgrade** > **Timing Device Turn On**.

Step 2 Click  to enable turning on or off the box by week or at a customized time.



**Custom** settings come first when **Custom** and **Week** are enabled at the same time.

Step 3 Click  to configure the specific date and time.

Step 4 Click **Save**.

## 6.7 Restarting the Box

Manually restart your device to solve problems such as system crash.

### Procedure

Step 1 On the home page, select **Settings** > **Maintenance and Upgrade**.

Step 2 Click **Restart Now**.

Step 3 Click **Confirm**.

The box starts restarting.

## 6.8 Viewing Device Information

On the home page, select **Settings** > **Terminal Info**, and then you can view device information such as device name, S/N, and app version.

# Appendix 1 Remote Control

For select models of play boxes, you can use remote controls to operate them.









- The remote control supports limited operations.
- The remote control for different models of boxes might be different.





Appendix Figure 1- 1 Remote control appearance



Appendix Table 1-1 Buttons description

Operation Item	Buttons Needed
Turn off or restart the box, turn off the screen	<p>When the box is turned on, press  and then select the operation.</p> <p></p> <p>For some models, you cannot use the remote control to turn off the box. You need to unplug the power cord to turn off the box.</p>
Turn off the box	<p>When the box is turned off, press  to turn it on.</p> <p></p> <p>For some models, you cannot use the remote control to turn on the box. You need to plug in the power cord to turn on the box.</p>
Turn on the screen	<p>When the screen is off, press  to turn on the screen.</p>
Adjust volume	<ul style="list-style-type: none"> <li>• Volume up: Press  and press right arrow button.</li> <li>• Volume down: Press  and press left arrow button.</li> </ul>



Operation Item	Buttons Needed
Type password to log in	<ol style="list-style-type: none"> <li>1. When you find the screen is locked, you can use your remote control to type the password. Press  on your remote control. The <b>Login</b> page is displayed.</li> <li>2. Operate arrow keys and move pointer to password box, and type password.</li> <li>3. Move pointer to <b>Done</b> on virtual keyboard.</li> <li>4. Move pointer to <b>OK</b> and press  on your remote control to log in to the device.</li> </ol>
Return to the previous page	Press  .
Return to the main menu	Press  .
Bring up the frequently used tool bar	Press  , and operate the left/right arrow keys to select a function you want.

# Appendix 2 Cybersecurity Recommendations

## **Mandatory actions to be taken for basic device network security:**

### **1. Use Strong Passwords**

Please refer to the following suggestions to set passwords:

- The length should not be less than 8 characters.
- Include at least two types of characters; character types include upper and lower case letters, numbers and symbols.
- Do not contain the account name or the account name in reverse order.
- Do not use continuous characters, such as 123, abc, etc.
- Do not use overlapped characters, such as 111, aaa, etc.

### **2. Update Firmware and Client Software in Time**

- According to the standard procedure in Tech-industry, we recommend to keep your device (such as NVR, DVR, IP camera, etc.) firmware up-to-date to ensure the system is equipped with the latest security patches and fixes. When the device is connected to the public network, it is recommended to enable the "auto-check for updates" function to obtain timely information of firmware updates released by the manufacturer.
- We suggest that you download and use the latest version of client software.

## **"Nice to have" recommendations to improve your device network security:**

### **1. Physical Protection**

We suggest that you perform physical protection to device, especially storage devices. For example, place the device in a special computer room and cabinet, and implement well-done access control permission and key management to prevent unauthorized personnel from carrying out physical contacts such as damaging hardware, unauthorized connection of removable device (such as USB flash disk, serial port), etc.

### **2. Change Passwords Regularly**

We suggest that you change passwords regularly to reduce the risk of being guessed or cracked.

### **3. Set and Update Passwords Reset Information Timely**

The device supports password reset function. Please set up related information for password reset in time, including the end user's mailbox and password protection questions. If the information changes, please modify it in time. When setting password protection questions, it is suggested not to use those that can be easily guessed.

### **4. Enable Account Lock**

The account lock feature is enabled by default, and we recommend you to keep it on to guarantee the account security. If an attacker attempts to log in with the wrong password several times, the corresponding account and the source IP address will be locked.

### **5. Change Default HTTP and Other Service Ports**

We suggest you to change default HTTP and other service ports into any set of numbers between 1024–65535, reducing the risk of outsiders being able to guess which ports you are using.

### **6. Enable HTTPS**

We suggest you to enable HTTPS, so that you visit Web service through a secure communication channel.

### **7. MAC Address Binding**

We recommend you to bind the IP and MAC address of the gateway to the device, thus reducing the risk of ARP spoofing.

### **8. Assign Accounts and Privileges Reasonably**

According to business and management requirements, reasonably add users and assign a minimum set of permissions to them.

#### 9. **Disable Unnecessary Services and Choose Secure Modes**

If not needed, it is recommended to turn off some services such as SNMP, SMTP, UPnP, etc., to reduce risks.

If necessary, it is highly recommended that you use safe modes, including but not limited to the following services:

- SNMP: Choose SNMP v3, and set up strong encryption passwords and authentication passwords.
- SMTP: Choose TLS to access mailbox server.
- FTP: Choose SFTP, and set up strong passwords.
- AP hotspot: Choose WPA2-PSK encryption mode, and set up strong passwords.

#### 10. **Audio and Video Encrypted Transmission**

If your audio and video data contents are very important or sensitive, we recommend that you use encrypted transmission function, to reduce the risk of audio and video data being stolen during transmission.

Reminder: encrypted transmission will cause some loss in transmission efficiency.

#### 11. **Secure Auditing**

- Check online users: we suggest that you check online users regularly to see if the device is logged in without authorization.
- Check device log: By viewing the logs, you can know the IP addresses that were used to log in to your devices and their key operations.

#### 12. **Network Log**

Due to the limited storage capacity of the device, the stored log is limited. If you need to save the log for a long time, it is recommended that you enable the network log function to ensure that the critical logs are synchronized to the network log server for tracing.

#### 13. **Construct a Safe Network Environment**

In order to better ensure the safety of device and reduce potential cyber risks, we recommend:

- Disable the port mapping function of the router to avoid direct access to the intranet devices from external network.
- The network should be partitioned and isolated according to the actual network needs. If there are no communication requirements between two sub networks, it is suggested to use VLAN, network GAP and other technologies to partition the network, so as to achieve the network isolation effect.
- Establish the 802.1x access authentication system to reduce the risk of unauthorized access to private networks.
- Enable IP/MAC address filtering function to limit the range of hosts allowed to access the device.